

# Anthropology of Habitat and Architecture

NOLD EGENTER

Architecture, as it is produced today in our urbanised environments, is based on restricted knowledge of its evolution. Postmodern 'theory of architecture' determined by conventional history of art with its limited concept of aesthetic values prevents scientific research and reasoning. The wider human condition is not integrated. Man appears only marginally as a user and is represented by standardised functional needs. Consequently, architectural anthropology maintains that theoretical horizons have to be widened. The term architecture is defined in new ways by integrating it into anthropological dimensions, including primatological and paleanthropological considerations. Seen thus, the term 'architecture' implies all that humans and their biological relatives built and build.

In the 20th century, there was considerable interest regarding the achievements of traditional 'architecture without architects' as proposed by Bernard Rudofsky in 1965. While many architects became actively involved in this direction of research, a world-wide movement emerged with numerous international associations focussing on the study of traditional environments. The most important result of these efforts can be seen in the *Encyclopaedia of Vernacular Architecture of the World* (1997) edited by Paul Oliver. Theoretically however, the encyclopedia's methodology is based on the disciplinary anthropology of the house without being conscious of the euro-centric origins of these

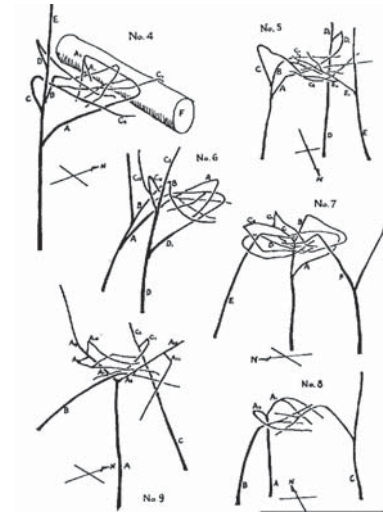

Schematic representation of construction methods of chimpanzee nests (Izawa/ Itani 1966)

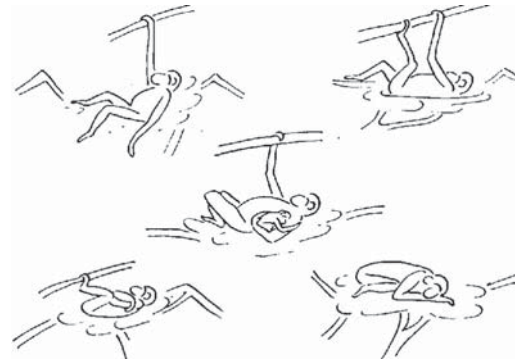

Typical positions of chimpanzees in nest (Goodall 1962)

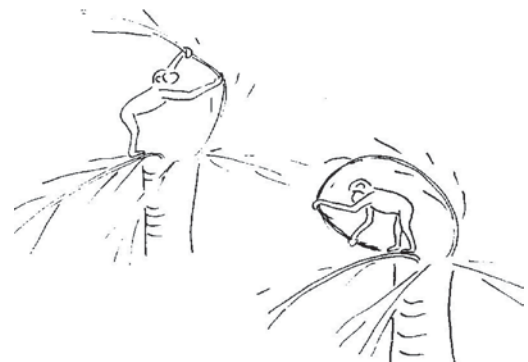

Chimpanzee female starts building a nest on top of a palm tree (Goodall 1962)

interpretations. Many characteristics of house traditions can not be explained in this framework.

The Viennese school of ethnology, and in particular Karl R. Wernhart (1981), has developed a new method called '*Structural History*' or '*Ethno-Pre-History*' which can be used for questioning the historicism separating the three temporally different disciplines in regard to material culture. Did fibrous materials and fibroconstructive processes play an important role in prehistory? Was the evolution of culture closely related to objects which were not durable? Were such objects representative for systems of ontologically high values? Such questions can be taken as a good reason to hypothetically introduce a new period into the periodic system of prehistory: [prelithic] fibroconstructive industries.

Architectural anthropology is closely related to Otto F. Bollnow's anthropology of space. In his book *Man and Space* (1963), Bollnow maintained that, in contrast to the homogeneous concept of universal space, essentially a discovery of the 14<sup>th</sup> century, cultural, or human space, is closely related to the evolution of human dwelling and settlement. This implies first, that human space perception and space conception originally were formed in small, local settlement units, in which architecture provided the semantic systems for spatial organisation. Second, we have to assume a long extension process of spatial perception and conception. In addition tectonic elements imply vertical and horizontal axial systems (e.g. 'access-place scheme' or 'vertical polarity scheme'). In the framework of a new 'habitat anthropology' we gain new and objective instruments for the reconstruction of basic spatio-cultural patterns with often surprising continuities.

These prerequisites allow a new view on the anthropologically defined concept of architecture. It works with five classes: subhuman, semantic, domestic, sedentary and urban/imperial architecture. These five classes are relatively independent fields of research. Combined with the results of conventional physical and cultural anthropology they can be taken as a new field of stimulating discussions. This shall be outlined in the following.

#### **SUBHUMAN ARCHITECTURE**

In their book 'The Great Apes' (1929) the American primatologist couple Robert W. and Ada W. Yerkes for the first time had systemically collected and studied

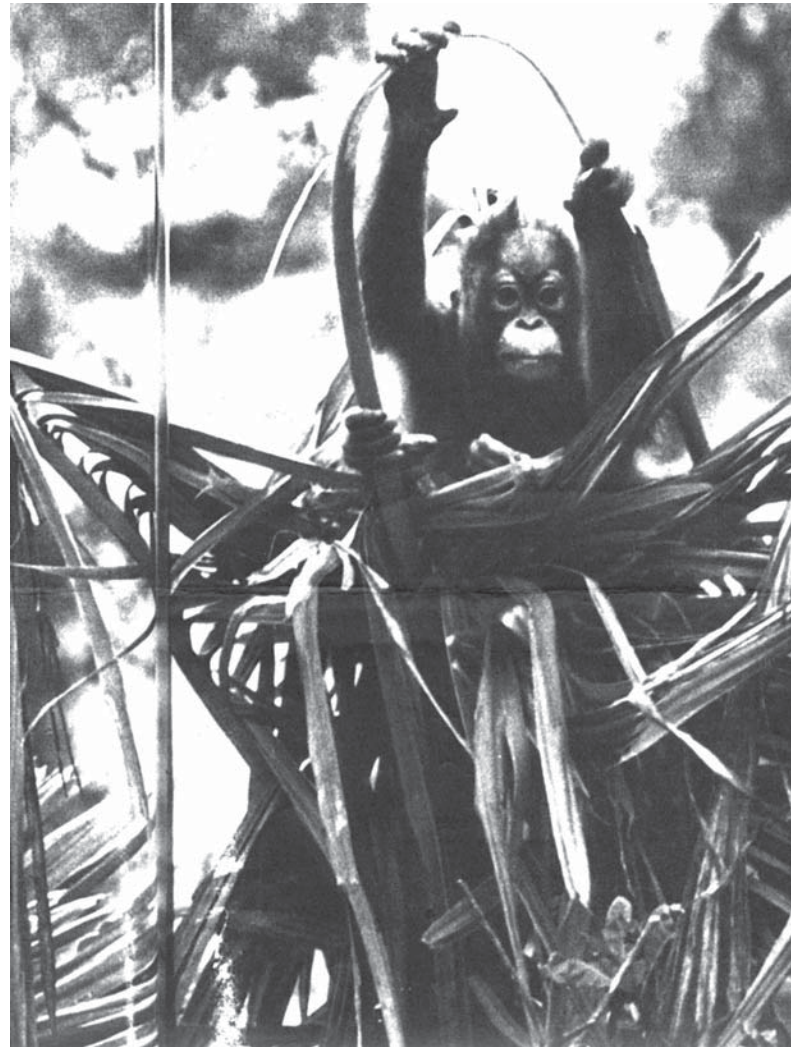

Young Orangutan building his nest on a betel-palmtree (Galdikas-Brindamour/ Brindamour 1975)

observations focussed on the nest building behaviour of the pongids. They considered nest building as a daily practised constructive behaviour which produced definitive alterations of the natural conditions of the environment. They therefore, postulated pongid nest building as the beginning of an 'evolution of constructivity'.

If, on the other hand, the suggestion of the Yerkes is taken seriously and the protocultural artefact character of the nest is emphasised, nest building behaviour is much more convincing as protocultural activity that is intimately connected to the life of the pongids. Infants spend about four years in the nest of their mother until they can build their own nest. Nest building is learned. The young play with nests. The

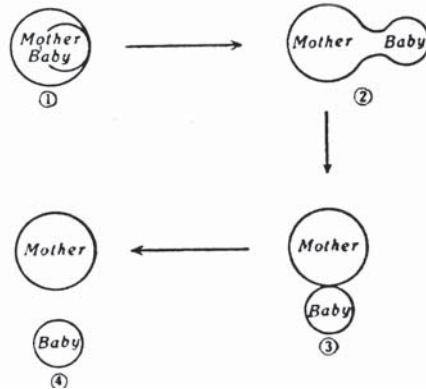
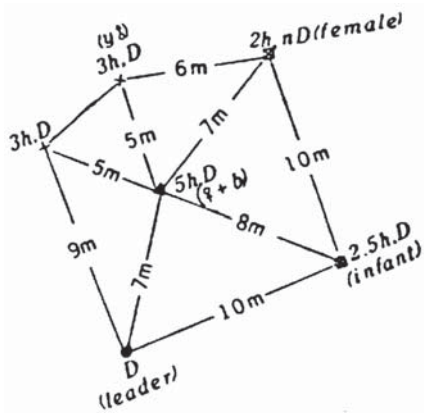

Plan of six gorilla nests in mountain wood characterized according to constructive types and users (Kawai/ Mizuhara 1959)

Mother and child relation regarding nest: 4 stages (Kawai/ Mizuhara 1954)

Same arrangement in perspective (Bamboo-wood is cut off for better vision; N. Egenter 1992)

completed nest produces an identification of the producer with his artefact. The nest is also used in case of sickness and imminent death.

Nest building is daily routine. Quantitatively too, nests are overwhelming. During its life an individual builds a virtual tower about eleven height of 11 times the height of the Eiffel tower. Construction implies specific physical conditions characteristic of humans: extensive rotation of the arms, a precise grip and stereoscopic view while controlling constructive processes. It requests judgement of constructive conditions, static quality etc. One can even speak of the psychology of the nest: several observers noted animals expressing safety and comfort when in their nests.

Night camps are an eminently social arrangement. Further, the night camp of a group shows a strategic organisation with a secured inside and a controlled outside, which is spatially not very different from the principles of a human apartment.

Most important is the differentiation of tree and ground nests. Whether tree or ground nests are built depends on various factors. Weight and age of the individuals are important as are environmental conditions which play a decisive role. Tree nests gain their stability from the structural condition of the tree top in which they are built. Ground nests are usually made with rooted plant materials which act as natural

foundations for instance, in bamboo stalks. On a height of three to four meters the stalks are bent, broken and knotted into stable triangles thus forming a perfectly stable type of tower. On its top the nest proper is made with thin, thoroughly interwoven twigs to form a smooth upholstery. Finally, the often heavy animals climb up, position themselves with their body into the central depression of the nest and spend the night sleeping.

Evidently the ground nest is a fully fledged work of architecture. But the ground nest is not only a primordial type of architecture.

If, the routine nest building is put into the foreground, the use of early tools as cutters for fibrous materials might have produced the 'first architectural revolution'. It was mentioned above that the building of the pongid ground nest is bound to the corresponding biotope (rooted materials). Consequently tools of the pebble tool type must have freed constructive work from this fixation to biotopic conditions. Materials could now be 'harvested' where they grew and could be carried to the 'construction site' where they could be combined with other materials. Material combinations of constructions could be extended. Stable and flexible materials could be integrated at the same place into the construction. A process of structural differentiation is initiated which might have led to an elementary material culture of the fibrous or fibroconstructive type.

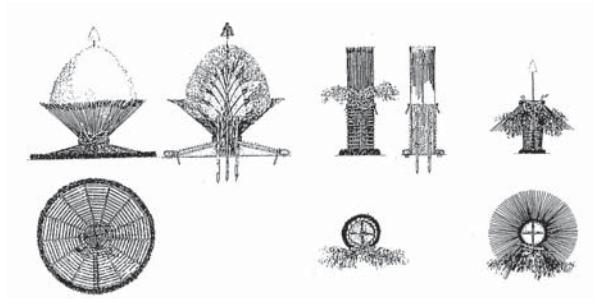

Vertical and horizontal sections of two basic hutlike and column- type forms in the same village (Ueda). At right is the female variation of the male column type

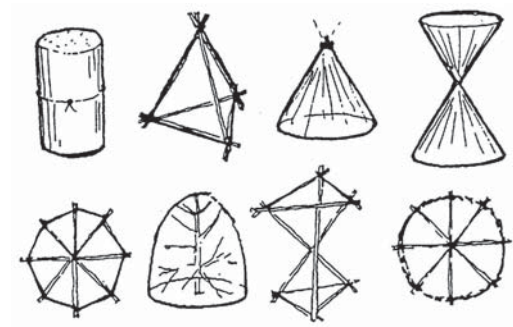

Geometry of the form - Note that Plato considered geometry of divine origin

**SEMANTIC ARCHITECTURE**

In their important ethnological study on traditional technology, Walter Hirschberg and Alfred Janata showed, that fibroconstructive industries are the main part of the material culture of traditional societies. They also play an important role in the building of dwellings. Tools are rarely used as the hand is the primary tool.

An example: the material culture of the Ainu as it is presented by Shigeru Kayano (1978) with precise technical drawings of 250 such tools, is of great importance here. A large part of the material culture of the Ainu reflects their palaeo-siberian roots - simply constructed traps, nets, cages, fish traps, baskets and bags for transport, boats, weapons, tools for various purposes. Toys for children and status symbols are also present as are small temporary hunting huts. These objects can easily be retro-projected into Mesolithic times, may be even into the Upper and Middle Palaeolithic. It seems that material culture was much richer than the image projected by archaeological studies.

Further, the Ainu have an extraordinary topo-semantic sign system, their 'inau'. John Batchelor, who was considered an authority on the Ainu, described these signs under the Euro-centric concept of 'primitive religion'. However, earlier, Willy Kremp (1928) had discovered the territorial implications of the Ainu signs within the framework of a systematic survey. They are primarily related to dwelling, but in a larger sense they are also used to control economical 'incomes'. The altar behind the Ainu house functions as a co-ordination point for gift exchange for all that comes in from the wilderness to the house through

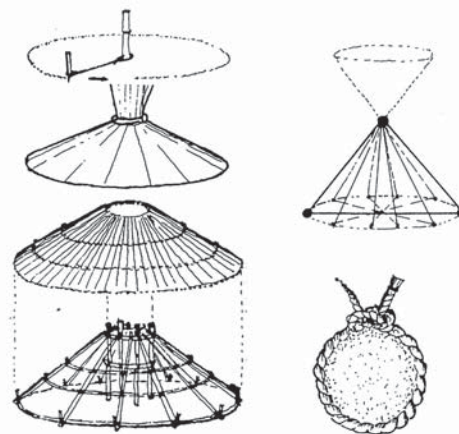

Geometry is produced by a specific technology- a bundle of stalks will always be round, cylindric

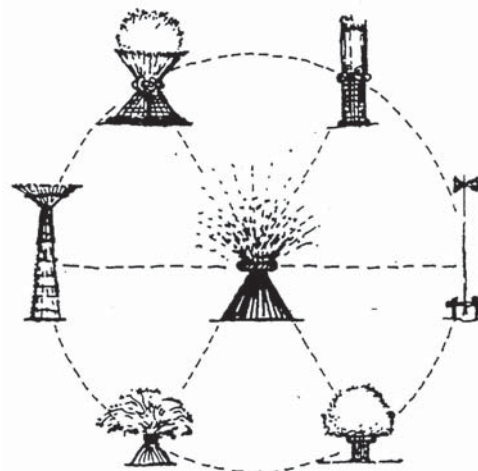

Philosophy: forms are differentiated following their function as territorial representation, but they have a common structure and show categorical polarity. This principle of 'polar analogy' shown in this scheme is very important for the anthropology of cognition

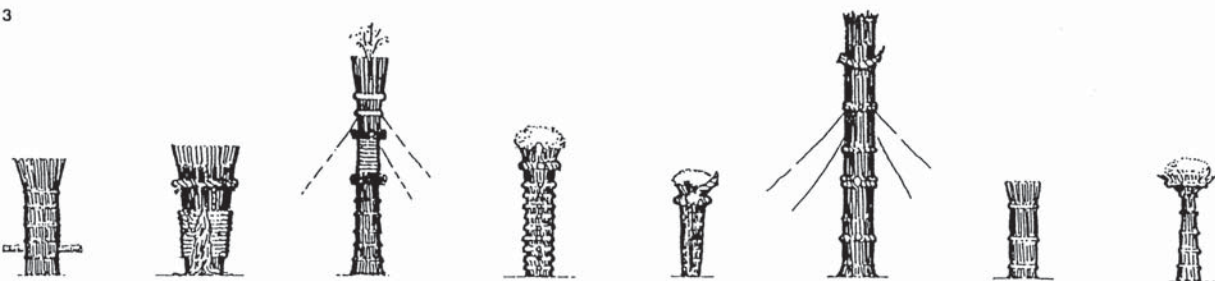
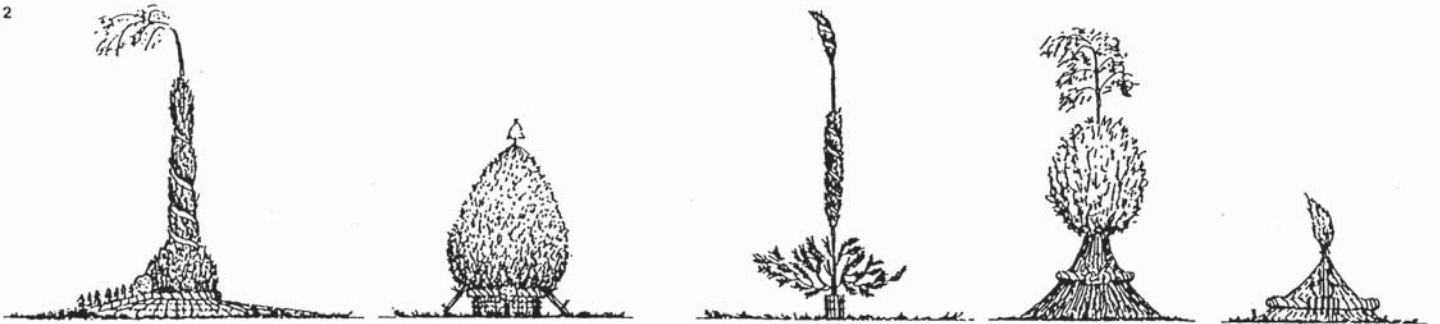

Fibroconstructive 'semantic architecture' surveyed in 100 villages of Central Japan. Locally they are considered as the 'seat' of the village protective deity (*ujigami*). Such toposemantic and stucturo-symbolic markers are still widespread in Japan. It is possible that before the introduction of wooden temple and shrine

architecture, these were the markers of sacred places in agrarian villages of Japan. In the framework of architectural theory, these signs must be considered as an age-old laboratory of architectural form, symbolism and toposemantic functions. Note the primordial rooted form. Column and hutlike forms differ in basic diameter only.

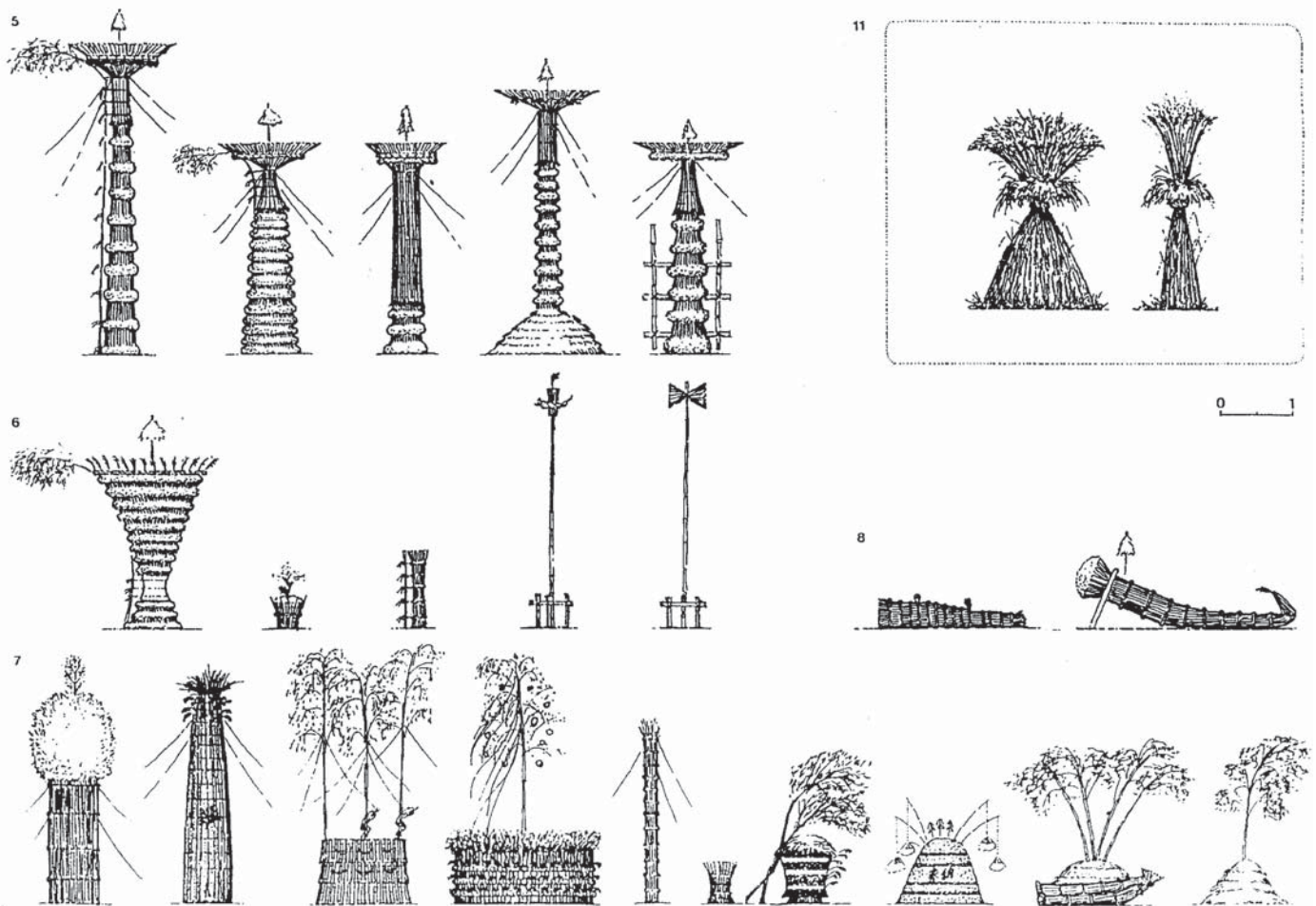

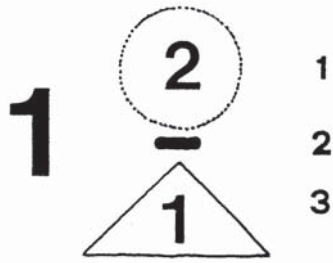

Philosophy: Territorially the forms are considered as units, but philosophically they are considered irrational, aesthetic forms which show the harmonious balance of two contradicting parts united by a third element, the (sacred) rope. As such they are models of categorical polarity and were evidently of great importance in the evolution of culture.

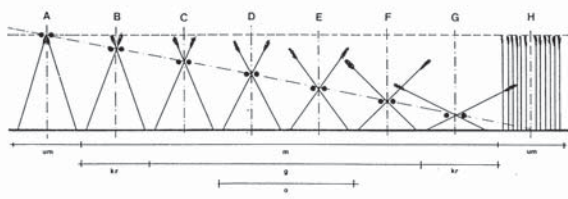

Theory of art: The term 'proportion' shows a new empirical dimension. A naturally mobile part (PRO) protrudes over a technically static part (portion). Evidently, this is a primordial type of what is called proportion in the abstract geometrical or mathematical sense.

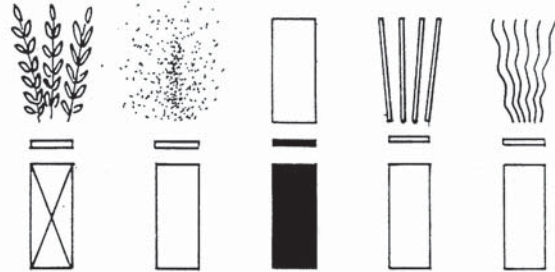

Philosophy: In the sense of objective science, it is impossible to describe these objects. They are technical and natural at the same time, clearly defined and ambiguous, compact and loose, static and mobile, one and many etc.. This is not a matter of lacking precision, it is their essence. We call this essence categorical polarity

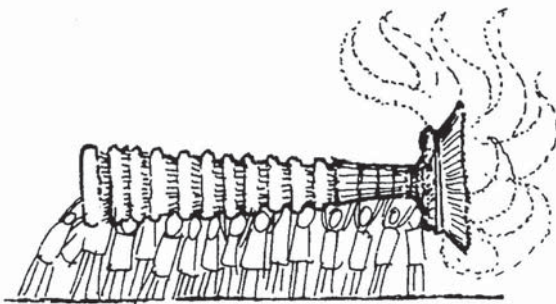

Symbolic function: The object has no fixed identity. Carried during the rite, the topo-semantic high pillar type changes into the mobile form of a fire spitting dragon or a boat



Symbolic function: The column type is considered male, its variation is female. The variation is not physical but related to traditional hair style, upwards and hanging down

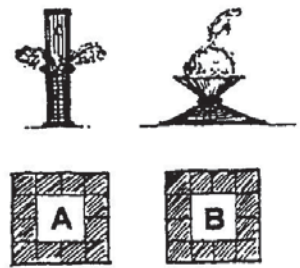

Forms vary from village to village to emphasise their territorially representative function

hunting, fishing, collecting and gardening. Hitoshi Watanabe (1973) has described the river system with mountain and ocean oriented contrasts and its role as an orientation system in the local cosmos. Emiko Ohnuki-Tierney (1972) too has contributed important data towards an understanding of these environmental orders controlled by signs, but she interpreted the Ainu microcosm macro-cosmologically, following Mircea Eliade's Euro-theological concept.

Japanese agrarian culture also contains numerous indicators of autonomous local cultures with

fibroconstructive industries. With the title 'Straw' (*wara*), Kiyoshi Miyazaki (1985) has described the rural straw culture of Japan in a beautiful two-volume study including coats, bags, shoes and other practical things, but objects of ontologically high value that are related to the world view of Japanese farmers. This fibroconstructive culture is without doubt more ancient than what we know of from the Yayoi period of Japanese object culture. Without doubt, it was carried along as a vital tradition by the early agrarian settlers. The autonomy of the tradition might have been helpful for local integration.

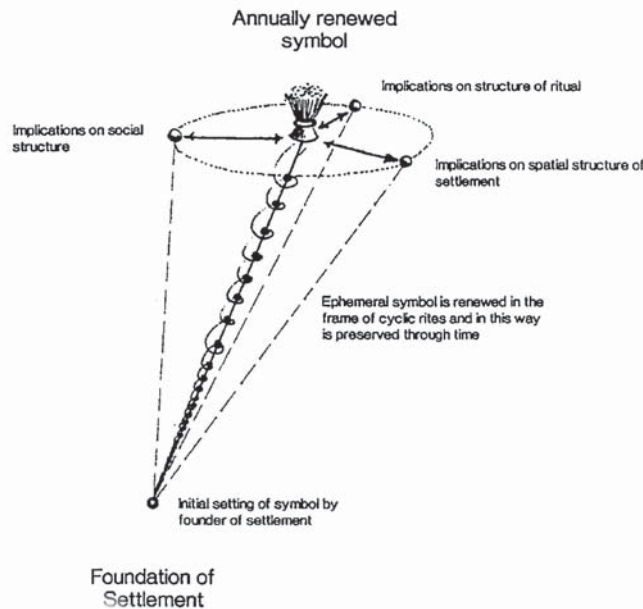

Settlement Core Complex: the marker set up by the village founder as a 'nuclear border' in the 'centre' of the (planned) settlement is cyclically renewed in the framework of a local event of ontologically high values. The marker functions as an archive of village history and local constitution defining the founder line as chief, head priest and local ruler. This structural model allows new interpretations of state formation in continuity with 'predynastic' agrarian village cultures.

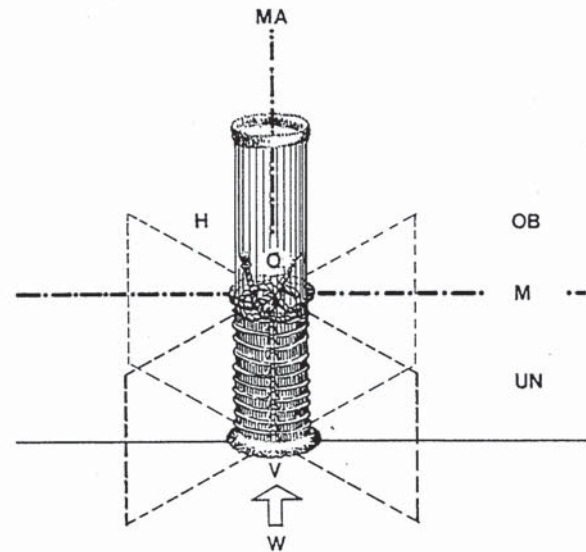

Semantic architecture as a place-marker in a system of spatial organisation. The column type shows an interactive front (knot) and a 'transcendental' back part. The human access path stops in front, defining a 'face' with spatially equivalent sides. Vertically it sets up an axial system structured according to polar categories, the upper part being empty and mobile, the lower part compact, massive and technically emphasised (12 ropes for the 12 months, 1 sacred rope for the year)

However, most surprising in Japan are the traditions that have been preserved in the framework of traditional village Shinto - a fibroconstructive topo-semantic system which has traditionally until today survived in a surprising density. The elementary technological characteristics appear in combination with highest ontological values (sacrality). The signs are considered deities or temporary seats of local gods and are completely integrated into historical Shinto. In the framework of architectural anthropology, the tradition can be considered as an archive of local village history. In the framework of the cyclic renewal of cults, the signs document the early residence of ancient families or of the settlement founder line represented by one or several houses. Since these houses express a moderate hegemony in the villages, the cult also supports the political and social structure of the settlement. The fibrous nuclear border demarcation set up on the occasion of the settlement foundation is renewed.

In the case of Japan we become aware that such fibrous topo-semantic demarcations must have been an important structural characteristic of prehistoric agrarian settlements. Guenther Kapfhammer's book on alpine traditions of Central Europe (1977) discusses the presence of such demarcations as maypoles and the like within European folklore. They also appear in many traditional cultures as 'fetishes' and 'idols', i.e. in the framework of the so called 'lower mythology' of history as defined by Sir James George Frazer and William Manhardt. In the discipline of Archaeology they are known as life-trees and they appear in many forms throughout the Bronze Age. It is likely that many of the rock-art 'tectiformes' had similar functions. Semantic architecture can thus be taken as an universal architectural type of pre-domestic significance. Semantic architecture was therefore probably the experimental field of architectural form and corresponding symbolic meanings.



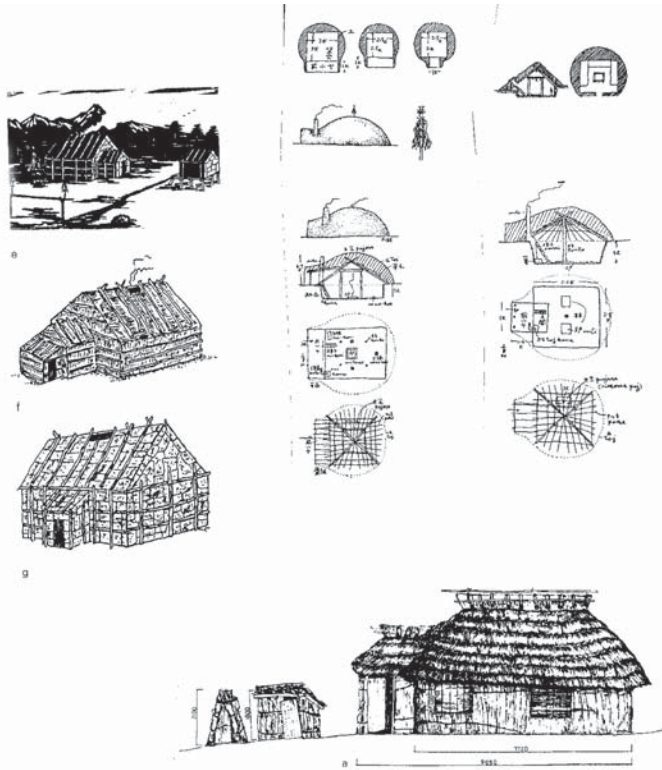

Conventionally traditional huts and houses were considered 'primitive' simple, and hence not worth of studying. This is entirely fallacious, especially, if local cults with toposemantic signs are included. They reveal highly complex systems of appropriation of the environment and creation of local identity. Together with the adaption of needs to local conditions, they provide an incredible degree of autonomy, a value that has been neglected in conventional studies. This illustration shows variations of AINU huts and house-types

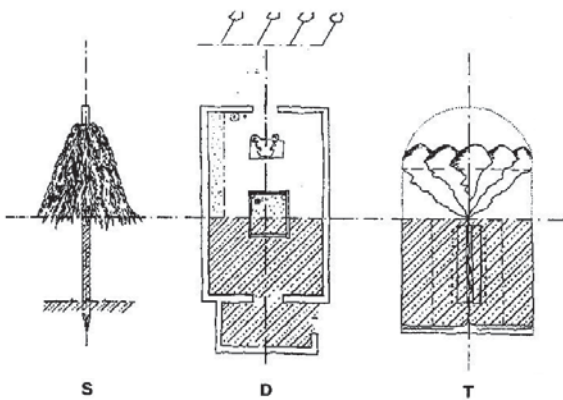
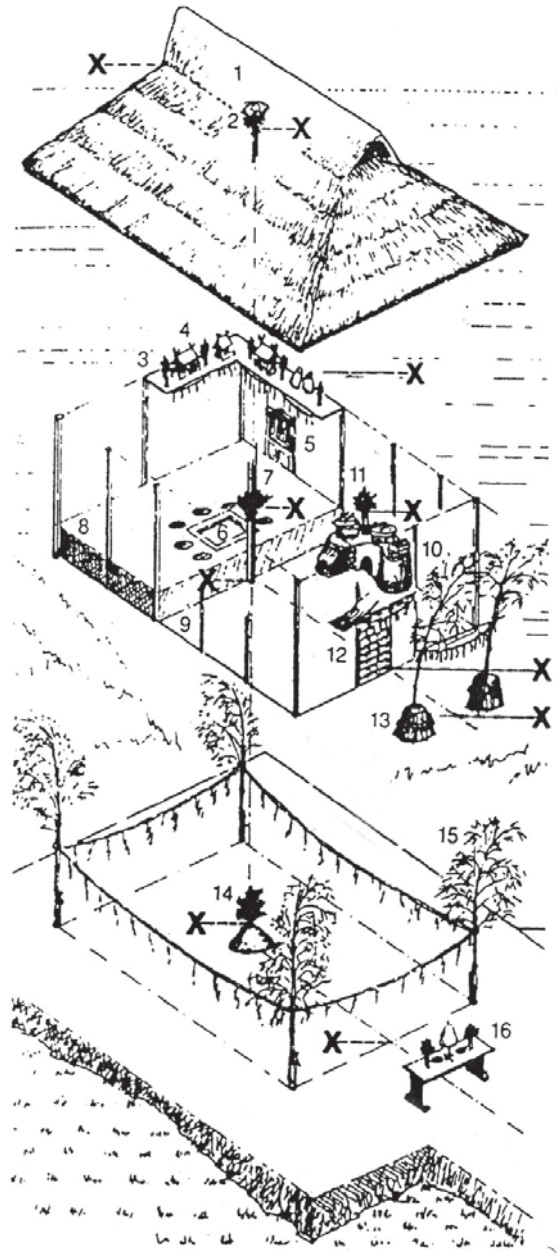

A house of the AINU, particularly at the occasion of their most important bear festival, as well as the whole valley in regard to its complex condition are both organised harmoniously according to categorically polar principles. The sacred signs of the AINU tradition (inau) act as models of this philosophy

A study the AINU house in the context of its construction rites and annual cults focussed in various parts of the house at the agrarian level too, reveals the traditional house defined in highly complex ways by toposemantic architectural elements. Here too, the house is not at all planned according to functional principles. In all its essential aspects it is definitely an expression of the categorically polar organisation of space derived from semantic architecture which appears during specific festivals related to the house.

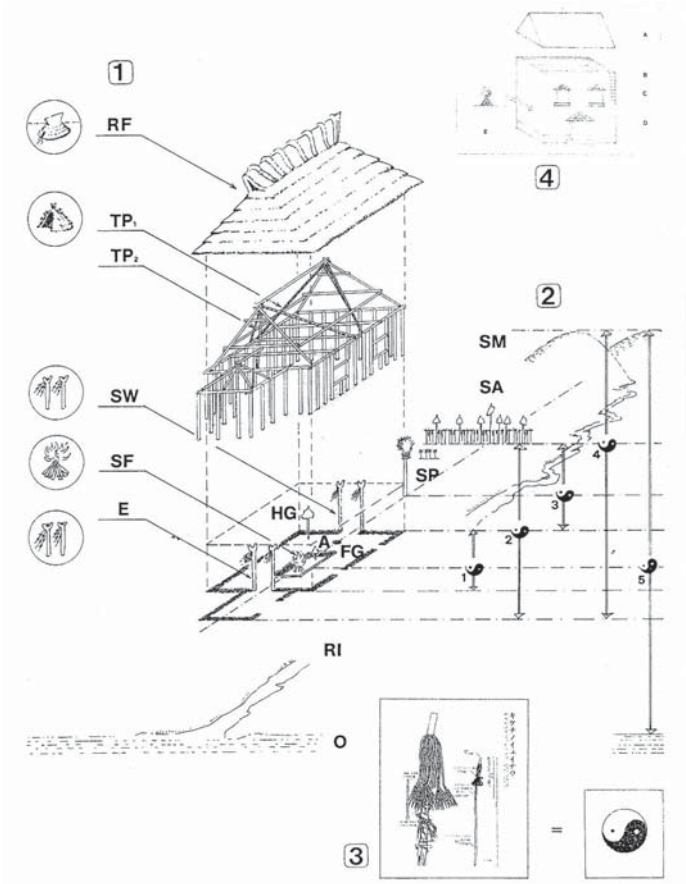

The Ainu house and the harmonious structure of environment in the framework of the Ainu world-view (Egenter 1991)

elementary social hierarchy (man/woman, noble/ commoner). The dialogue between semantic architecture and natural form can be used for the cultural perception of nature in the form of categorically polar analogies. Very likely polarity, as a cognitive system, has produced an elementary aesthetic revolution which can still be observed in many traditional societies. And, in fact, its structure survives in many aspects of modern perceptions.

**DOMESTIC ARCHITECTURE**

By assuming a primary topo-semantic stratum in the architectural evolution outlined in the previous section, we gain new indicators for the development of domestic architecture. The so called ‘shelter theory’, that is, the assumption that man invented protective roofs or windbreaks against excessive climatic influences, reveals a functional retroprojection. If huts and houses are interpreted as composite developments, we discover basic architectural schemes such as the ‘access place scheme’ in which semantic architecture defines the elementary plan with ‘place and gate markers’ in tandem with other elements derived from semantic architecture. House altars and house gods serve as place markers while sacred door posts as gate markers. Traditional house plans are often extremely conservative inspite of changing materials and flexible outer form of the houses. The ontologically high

Here meaning is expressed with the most elementary forms and is produced autonomously by the constructive process, without any preconceived idea of the producer. The expression can be characterised as ‘categorical polarity’ or ‘coincidence of opposites’. In the tradition of the 100 villages researched by the author (1994) it is clearly shown that the primary geometrical form, essentially column or hut type, followed a trend of local differentiation and enters into dialogue with natural forms via the ‘coincidence of opposites’ imbedded in the same form as a ‘general principle’. The convergence of artefact and natural form is created through the categorical polarity of the topo-semantic system, respectively through the ‘polar analogy’ of both forms. The artificial forms remain dominantly characterised by structural conditions, technique and geometry.

Landscape too seems to be structured according to this principle of polarity. Time can be perceived in polar relations (night/day, sun/moon) and similarly

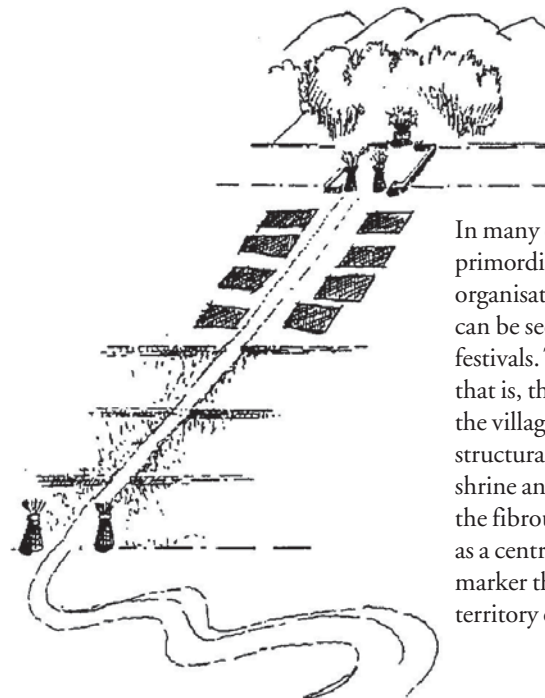

In many cases, the primordial spatial organisation of the village can be seen at such festivals. The access path, that is, the ‘mainstreet’ of the village forms its main structural element. The shrine and its precursor, the fibrous prototype, acts as a central and border-marker thus defining the territory of the village



Perspective of a typical Japanese farming village at the festival of the village protector deity (ujigami). The fibroconstructive marker (semantic architecture) is built with reed and bamboo in front of the wooden shrine. The cult association of elderly men moves towards the shrine at the edge of the rice fields in the woods. Originally when there was no wooden shrine yet, the fibrous marker remained there for one year until it was destroyed and then renewed. Today it is built in one day and destroyed by fire, usually on the same or the next day. The fibroconstructive type thus represents the precursor of the wooden shrine

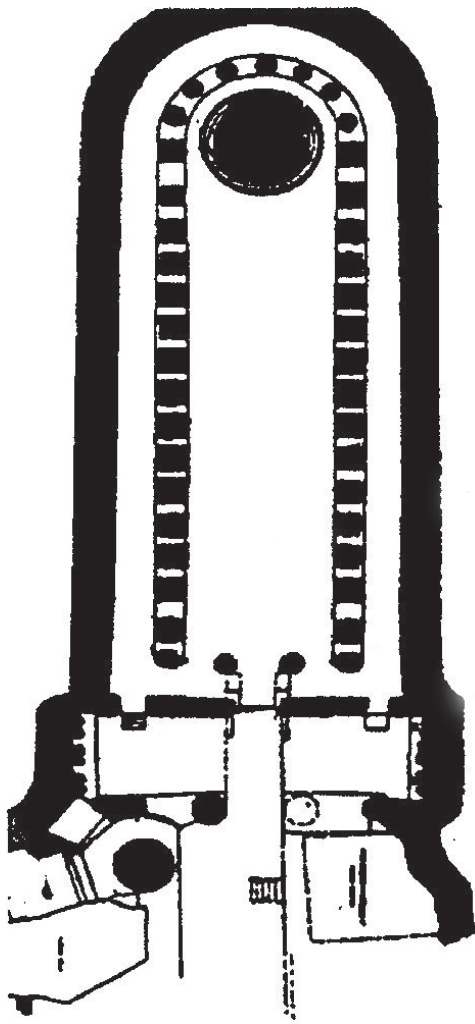

This type of defining space is widespread across the globe and highly continuous, particularly in the domain of sacred space. Here an example from India may be added, a Chaitya hall focussed on its place marker with an access defined by gate markers

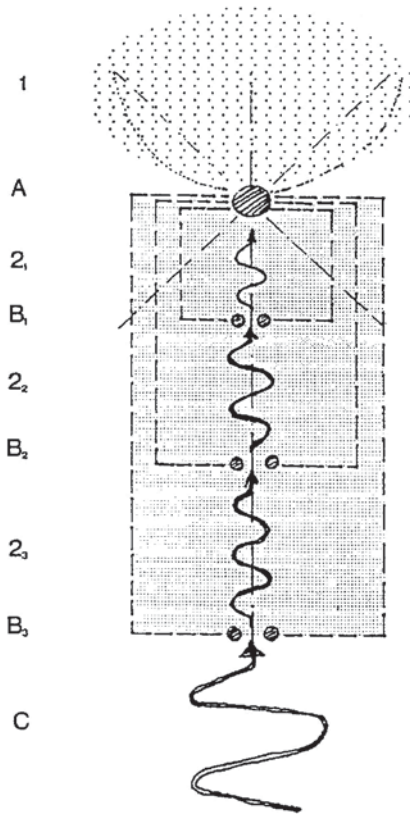

Gates found in the shrine precinct define a ritual space related to the shrine. Often, the same gates are found at the village entrance secluding it from the outside world and focussing its surfaces on the ontologically highest point, the place marker of the shrine and the temporary sacred sign

ranking demarcations appear fixed by cyclic cults, which were originally focussed on their renewal. The fire in the open hearth reveals as an independent construction, which entered the house or the hut while preserving its own ontological autonomy. Similarly the roof can be derived as independent development of hut-like signs. This program was essentially derived from two traditions studied in depth - various house types of the Ainu and the farmhouses of Japan. Both house traditions and their variation, are not developed according to functional principles. Both correspond to accumulations of relatively independent elements derived from a pre-domestic topo-semantic layer, which defined living space with cyclically renewed topo-semantic demarcations. This creates a central and important requisite for the research of houses - related cults must be included into research.

#### **SEDENTARY ARCHITECTURE**

In the following we will shortly discuss an important insight of the approach - the evolution of territorial control and sedentary life. The Mesolithic era witnessed the evolution of a cultural dimension, which can be understood from its developed form, but cannot be reconstructed archaeologically with its factual conditions. Here too the ethno-pre-historical method shows a new potential to better understand the phenomenon of the increasing capacity for territorial control and, finally, of permanent sedentarity from its institutional conditions.

The Mesolithic is characterised by increasingly sedentary communities and by the capacity to collect a broad spectrum of food. While, the conditions of the new level are not clear, comparison with the ethnological situation clearly shows the importance of topo-semantic systems. In the case of the Ainu it is evident, that broad spectrum food gathering is controlled by a fibroconstructive topo-semantic system. In the framework of a categorically polar system the topo-semantic signs relate the antithetic categories of inside and outside. The fibroconstructive signs form the threshold points of gift exchange between man and wilderness. Rooted in the intimate space of dwelling, they extend into wider zones of hunting and collecting within the valley that constitutes the home range of the Ainu. A complex system of categorical polarity also controls time, social role and communal cooperation. In short, the comparison with the ethnological situation gives us very clear ideas about the structural conditions and

ontological principles according to which extended territorial control systems could have evolved.

The Neolithic is characterised by permanent agrarian settlements and domestication. More or less permanent occupation of a territory became important with pastoralism and agriculture. However, the question of how settlements were institutionally organised remains open. Architectural anthropology assumes that topo-semantic demarcation systems were already present already in the Mesolithic period and became dominant in Neolithic times. They proved highly efficient in the protection of sedentary life and consequently, produced high ontological values among local populations. The terms 'nuclear border' and 'settlement core complex' are crucial in this regard. Nuclear border demarcations were set up in the middle of settlements. The fibrous demarcation remains within the controlled zone of the settlement. The categorically polar structure of 'semantic architecture' is projected spatially towards the outside, producing village plans with complementary surfaces, functional and non-functional domains. First, this must have been effective within regional settlement systems. It also developed a system of ontological values which further protected the settlement. Polarity had become an established ontological value related to the signs. They were used as models of harmonious organisation of space, time and social organisation. This also implied a primary type of aesthetics, which provided value to the settlement as a whole. The cyclic renewal of the same fibroconstructive demarcations introduced temporal depth into the settlement's consciousness. Further, an elementary social hierarchy developed within agrarian villages. Through cyclic cultic renewal the demarcation system remained related to the foundation of the settlement, an aspect which is locally shown in the founder house line. The founder house develops hegemonic claims. Its representant appears with dominant functions in renewal cults. He is priest and chief or ruler of the settlement. Thus, the topo-semantic system had the function of a traditional local constitution. Semantic architecture can be taken as a scriptless archive of settlement history which was probably a basic institution of Neolithic village cultures.

#### **URBAN AND IMPERIAL ARCHITECTURE**

The formation of early civilisations in the Bronze Age is the field where architectural anthropology clearly



Various types of columns used in temples of Ancient Egypt. Though this monumentalised types are hewn in stone, their primary fibroconstructive condition clearly expressed in their texture. The temple architecture of Ancient Egypt is thus not a new invention of ingenious designers (Spiro Kostof), but the monumentalisation of the fibroconstructive architecture of predynastic agrarian villages



Abbildung 13.  
Nymphaea Lotus-Stüle mit geschlossenem Kapitell  
zu Philae am Tempel der Isis-Worcht.  
Sp. Z.; Phalanisch. Nach L. D. I, 107.

①

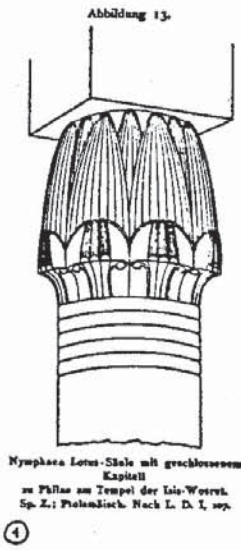

Abbildung 9.  
Nymphaea Lotus-Stüle mit geschlossenem Kapitell;  
a. R. Grab des Ptah-schepes, Abusir. Dynastie 5; nach de Morgan, Rev. arch.  
1892, S. 267p.

④

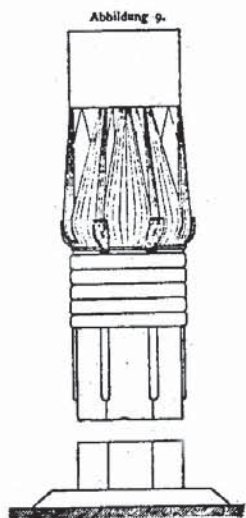

Abbildung 12.  
Nach einem Wandgemälde im Grab 27 zu Benihasana; a. R. Nach Lepsius' Tagebuch.

②

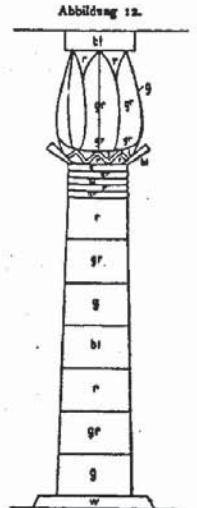
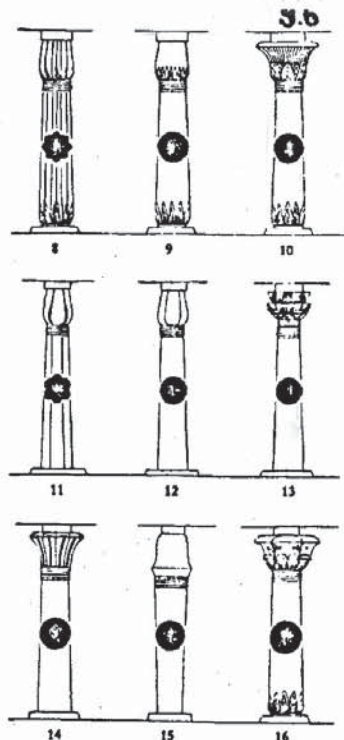
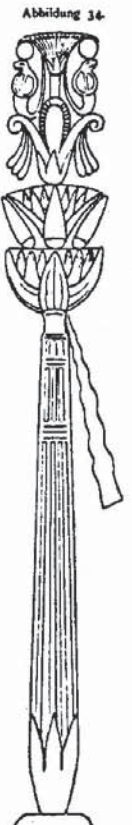

Abgebildete Bouquetstüle aus dem Grabe des Sem-nudem; a. R.; Dynastie 20; nach Bert. Mus. Ph. 064.

⑤



Einfach Papyrusstüle mit geschlossenem Kapitell.  
Wandgemälde aus Qurna Grab 9 des Cha-rem-het; a. R.; Dynastie 18; Zeit Amenophis III. Nach L. D. III, 77 u.

⑥

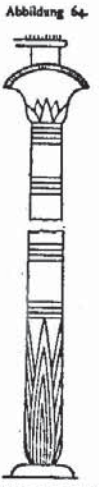

Offene Papyrus-Doldenstüle (mit Angabe der Blätter).  
Wandgemälde aus Gurna, Grab 15; a. R.; Dynastie 18; nach L. D. III, 76 b.

⑧



Fig. 60.

③

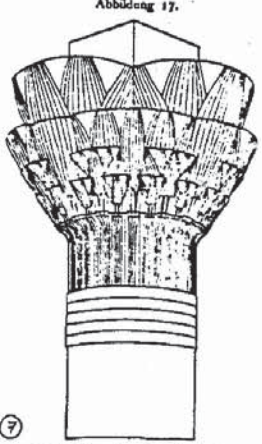

Offenes Nymphaea Lotus-Kapitell aus Wad. Phalanisch. Nach Lepsius' Tagebuch.

⑦

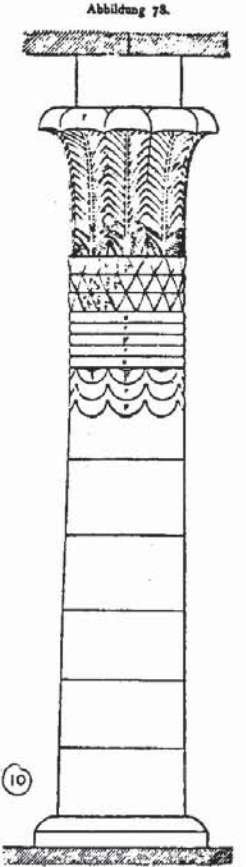

Palmestüle aus Philae. Sp. ZL. Zeit des Augustus und Tiberius; nach Berl. Museum, No. 3344. Ausföhr. Verzeichn. S. 22.

⑩

⑨

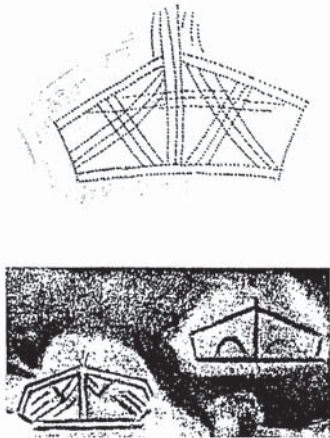

Paleolithic 'Tectiformes' of the hutlike type (Font de Gaume)

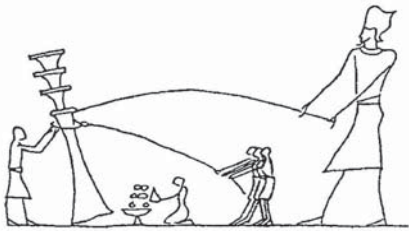

Pharaoh raising the Djed pillar at the 30-years' jubilee festival of his government

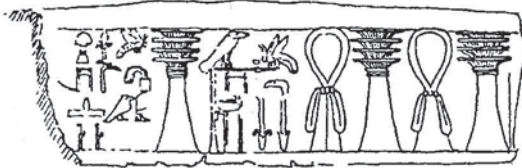

Egyptian sanctuary showing Djed pillar as a place marker and Djed pillars and 'Isis-knots' as gate markers (access-place scheme)



Ancient Near Eastern sanctuary in a cattle-breeder environment showing one flower-decorated fibroconstructive place-marker of the cylindrical type and two pairs of gate markers, one pair of the Ishtar sign type, one pair of the compact cylindrical type (access-place scheme)

shows its validity. Due to rich archaeological sources, the anthropological method outlined, provides considerable new insights into institutional processes.

Walter Andrae was a prominent figure of the German architecturo-archaeological research, which was active in Mesopotamia and Ancient Egypt in the thirties of the last century. Andrae has strongly emphasised this aspect of 'metabolism' between ephemeral and durable materials in this domain. In his book 'The Ionian Column, Built Form or Symbol?' (1933), he presented a great quantity of archaeological sources supporting the thesis of a fibroconstructive substrata among pre-dynastic village cultures of the Ancient Near East and Egypt.

This leads to an entirely new evaluation of early civilisation. Innovations were essentially of technological character. The first cities and empires owed their existence mainly to the 'monumentalisation' of cyclically renewed fibrous 'documents' of the constitutional archives of pre-dynastic villages. They were copied into durable materials, which allowed the spatial extension of empires. Villages could be controlled from impressively built cult centres as the top institution of a monumental theocratic system of territorial control. The material expenditures of the cyclic village cults were centralised on the higher level as taxes and labour. This allowed the accumulation of wealth in the centres. The cyclic time concept of the villages was superseded with linear time, expressed by 'eternal' buildings. As Hermann Kees (1980) has described clearly, hegemonic processes then developed on the regional district-level as well as on the imperial level with corresponding cults and temples. The originally autonomous agricultural settlement was subdued to centralised control by means of the monumentalised cult system. Theocracy appeared as a political form.

### CONCLUSION

Architecture defined in an anthropologically wider framework reveals new aspects of the human condition. Based primarily on 'constructivity' it appears closely related to the subhuman and human existence. Closely related to the anthropology of habitat, architecture shows important new aspects in regard to territorial organisation and sedentarisation as well as in view of the formation of early civilisations.

With increasing urbanisation of the world, rationalised architecture has become an important part of the modern human condition. But, architecture cannot be reconceived in its conventional circles anymore. The methods have to be extended towards global horizons introducing perspectives of anthropological temporal depths. 'Architectural theory' is a matter of anthropology. Anthropology will have to clarify the factual complexity of the architectural domain in regard to the human condition.

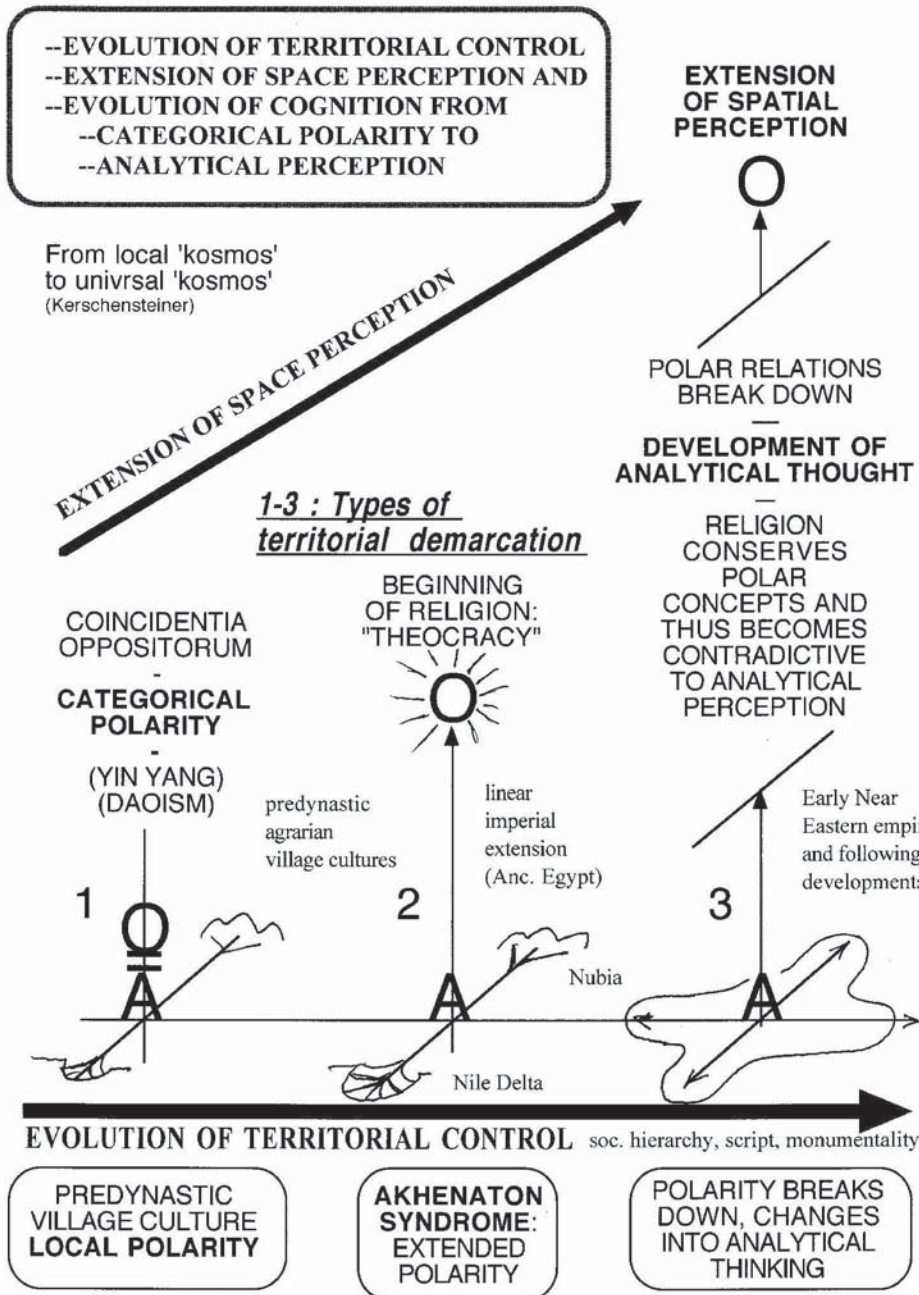

Working with Bollnow's evolution of human space perception we can understand afresh the processes of the extension of territorial control, the function of toposemantic demarcation as structural models and its impacts on the development of human cognition from concepts of categorical polarity (coincidentia oppositorum, or YinYang etc.) to analytical concepts in science and its conflicts with religion which remains essentially harmonious or polar in its expressions